



中国航天



XIN YANG

沈阳航天新阳速冻设备制造有限公司

XIN YANG

新阳



CHINA SHENYANG AERO SPACE XINYANG QUICK FREEZING EQUIP MANUF CO., LTD



Enterprise resume

Shenyang Aero Space Xinyang Quick Freezing Equip. Manuf. Co., Ltd.

Xinyang Company, National agricultural products processing equipment professional R & D branch Center, established in 1985, is a specialized enterprise engaged in food machinery development and manufacturing. It is the biggest producer in China, mainly assuming the research and production of products such as food quick freezer and vacuum freeze drying equipment. Our company has been certified in accordance with ISO9001-2008 quality system, and properly completed the state "tenth five-year plan" in the development and research of quick freezing machine that is low-energy-consumption and big-production. At the same time, the company has undertaken the state "eleventh five-year plan" to research and developed the continuous type of freeze drying equipment. LG Series freeze drying equipment developed by the company obtains the second-class prize awarded by the State Defense Scientific and Technological Commission, and is recognized as advanced international key product by Ministry of Science and Technology. The company has provided more than 1800 sets of vacuum freeze dryer at home and abroad.

Starting from 1980s, the company led to promote the SS-1 fluidized bed quick freezer and has developed more than 30 models of food quick freezing installments with the advanced international level, which are suitable for processing vegetable, fruit, seafood, meat and pre-made foods, as well as many kinds of vacuum freeze dryer, pre-treatment line, vacuum cooling equipment and vacuum fryer, etc. The IQF and vacuum freeze drying equipment have exported to many countries including United States, Canada, Denmark, Germany, Chile, Thailand, Singapore, Nigeria, Malaysia, Korea, Japan, Palestine, Burma, Indonesia. Advanced design, fine manufacture and efficient energy-saving meet the current needs of freeze drying industry and agricultural product deeply processing, leading an important part as the world top.

The company has received many honorary titles awarded by the State Economic and Trade Commission, the Ministry of Science and Technology, the State Commission of Science and Technology for National Defense Industry, the Ministry of Astronautics and the Ministry of Agriculture. The company is the drafting unit, assigned by the Ministry of Commercial, of the technical standard of freeze-drying equipment and quick-freezing installment. The Standard number is SB/T10430-2007. The company has also obtained the qualification of export, the certificate of recognition of new and hi-tech enterprise issued by Liaoning Province and Shenyang City. In addition, it is the outstanding unit in drying industry of China. Xinyang company has the qualification certificates include Pressure Vessel Design Qualification (TS1221101), Pressure Pipeline Design Qualification(TS1821060-2019) and Pressure Pipeline Installation Qualification(TS3821073-2018).

Adhering to the purpose of people-oriented and the aim of Integrity, pragmatic and innovation, the company makes a great effort to create "Xinyang" brand and leads both domestic and international market by virtue of strong strength of space technology.

Main Products



LG Series Food Freezing-Drying Equipment

This equipment can be used for processing many kinds of food, such as meat, vegetable, fruit, marine products, soymilk, beverage, soup, health products, etc., making the products meet the requirement of being natural, nutritious and convenient.

LG Series Pilot Freeze-drying Machine

This machine can be compatible with freeze-drying equipment for production, used for researching of process parameter control curve for various materials to be dried and to seek optimum process scheme.

Series Food Quick Freezing Equipment

Altogether there are six series: SS, TS, JS, WS, YDS, which can be used for quick freezing and preservation of fruit, vegetable, marine products, cut meat, ice cream, small package food and various flavored food.

YL Series Fruit & Vegetable Pretreatment Processing Line

Including three parts: washing, blanching, cooling. It is used for pretreatment before quick freezing and freeze-drying. Each part can work independently, and users can select according to their needs.

ZL Series Vegetable and Fruit Vacuum Cooling Equipment

This equipment is suitable for precooling treatment of vegetable, fruits, flowers from their being picked to storage, marketing, keeping required freshness.

ZDY Type Fruit & Vegetable Vacuum Frying Equipment

This equipment is used for vacuum frying of apple, potato, carrot as brittle chip and peanut, soybean, etc. As frying, dehydration and deoiling are undertaken under low temperature and vacuum conditions, damage of nutrition, cluster is reduced to the minimum. It is an ideal equipment for processing of various children food and leisure food.



连续式油炸生产线
Continuous Vacuum Fryer



间歇式油炸设备
Intermittent frying equipment



自堆积带式螺旋速冻装置
Self accumulation belt type spiral quick freezing device



JS系列食品速冻装置
JS series food quick freezing equipment



LX轨道式螺旋速冻装置
LX Series helical quick-freezing equipment



YL系列果菜加工预处理生产线
YL series Fruit&vegetable pretreatment Processing Line

LG Series Food Freeze-drying Equipment

LG series freeze-drying equipment is manufactured on the basis of experiences in areas such as heat transmission, vacuum, refrigeration, pressure vessel manufacturing and automatic control, integrated international advanced technology.

According to the loading capacity of product and its applicability, it can be divided into small (including experimental), medium and large freeze-drying equipment.



Experimental type

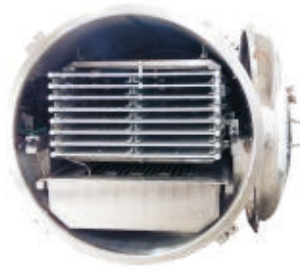

Medium type



Large type

built-in cold trap with Freon. It's suitable for large and medium institutions, research institutes and other organizations for samples and crafts research, especially suitable for small production with high value-added.

Large and medium sized equipments adopt advanced technologies such as alternative built-in cold trap, full-liquid circulating cooling, and negative-pressure steam de-icing, featuring on high automatic, easy to operate, small investment and low energy consumption. Multiple chambers can be used together to achieve higher production.

This series equipments apply to process wide range of products, such as;

Vegetable: edible mushroom, diced garlic, chives, onion, green beans, peas, diced cucumber, sweet corn, diced carrot, spinach, asparagus, edible wild herbs etc.

Seafood and Meat: conpoy, shrimp meat, fish fillets, beef, pork, chicken, mutton cut and slice etc.

Flavored Products: garlic Powder, ginger powder, onion powder, tomato, pepper powder.

Instant soluble beverage: coffee, tea, soup, soymilk, milk etc.

Convenient Food: Children's food, TV food military camp food.

fresh Traditional Chinese Medicines: ginseng, piloseantler, chinese wolfberry, etc.

Freeze dried food will bring benefit to you:

- Maintain food's original color, perfume, taste, shape, proteins and vitamin
- Natural, no preservatives added, light in weight and easy to transport
- Quick rehydration and convenient to eat
- Preserved under normal temperature, without need for complex cold-chain
- Excellent preservation ability and long shelf life



Rated parameters of small freeze-drying equipment

Parameters	LG-0.2	LG-1.0	LG-1.5	LG-5	LG-10	LG-20
Heating area (m ²)	0.2	0.8	1.5	5.3	10	20
Loading capacity (Kg/batch)	3	10	20	70	140	260
Rated maximum water trapping capacity (kg/batch)	2kg/batch	8kg/batch	15kg/batch	60kg/batch	120kg/batch	250kg/batch
Heating method	Double side radiation					
Heating media	Electricity heaters			Deionized water		
Adjustable temperature range of heating plate(°C)	Room temperature ~+120			≤90	≤90	≤90
Vacuum pressure of working	≥50Pa					
Supporting refrigeration capacity (t ₀ =-40°C t _k =35°C)(kw)	With compressor unit				18	44
Consumption capacity of steam vapor 0.7MPa(kg/h)	Electrical heating				50	75
Installed power(kw)	3.2	8.5	15	41	38	38

Rated parameters of medium and large freeze-drying equipment

Parameters	LG-30	LG-50	LG-75	LG-100	LG-125	LG-200
Heating area (m ²)	30	50	75	100	125	200
Loading capacity (Kg/batch)	400	600	900	1200	1500	2400
Rated maximum water trapping capacity (kg/batch)	60kg/h	110kg/h	165kg/h	220kg/h	275kg/h	440kg/h
Heating method	Double side radiation					
Heating media	Deionized water					
Adjustable temperature range of heating plate(°C)	≤90	Room temperature ~+120				
Vacuum pressure of working	≥50Pa					
Supporting refrigeration capacity (t ₀ =-40°C t _k =35°C)(kw)	55	80	120	160	200	320
Consumption capacity of steam vapor 0.7MPa(kg/h)	150	200	280	340	400	690
Installed power(kw)	96	43	63	69	85	115



LX Series Spiral Freezer

Stainless steel mesh belt of LX Series Spiral Freezer runs helically in freezing room, realizing quick-freezing of feeding materials. It can be divided into two kinds: Single Spiral Freezer (DLX) and Double Spiral Freezer (SLX). LX Series Spiral Freezer adopt side air blowing. The freezing time is adjustable from 15 to 60 minutes. This series equipment is suitable for marine products, prepared foods, fruits and vegetables, cut meat, ice cream and poultry, etc.

Structural Drawing and Technical Parameters of Single Spiral Freezer

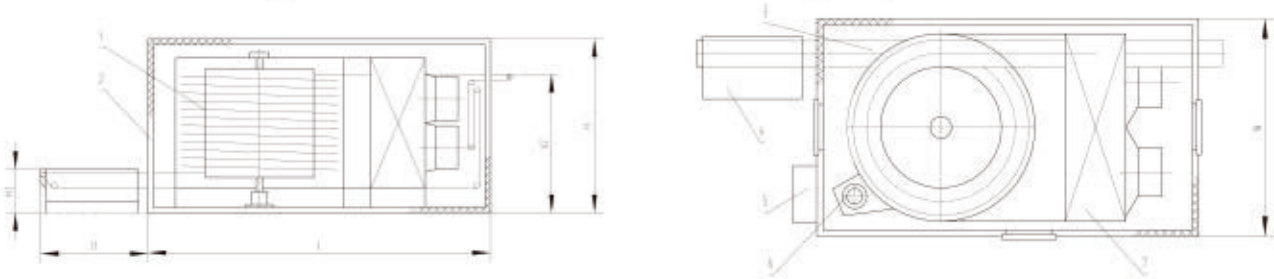

Main Tech. Para. of Single Spiral Quick-Freezing Equipment

For example as headless shrimp; refrigeration condition: T₀=-40°C Tk=35°C

Model Para. Item	Output (kg/h)	Feeding temp. (°C)	Outfeeding temp. (°C)	Cycle cold air temp. when no loading (°C)	Installed power (kw)	Dimension of quick freezing room (L×W×H) (m)	Overall length for mesh belt (m)	Overall width for mesh belt (mm)	Required refrigeration capacity (kw)	Number of layers	Height between layers (mm)
DLX-300	300	15	-18	-30±2	10	7.5×5×2.5	97	650	70	1×6	145
DLX-500	500	15	-18	-30±2	14	7.5×5×2.9	135	650	100	1×9	145
DLX-1000	1000	15	-18	-30±2	28	9.05×7.2×3.1	240	800	180	1×11	152

Main Characteristics of DLX Single Spiral Freezer

- ◆ Short freezing time, best quality and low energy-consumption
- ◆ Stainless steel structure and fully safety in foods
- ◆ Equipped with production line can save energy and improve efficiency.



LX Series Spiral Freezer

In order to meet market requirements, Xinyang Company researched new double spiral freezer on the basis of experiences in single spiral freezer. It adopts two turning drums, showing the best advantages of spiral freezer.

Structural Drawing and Technical Parameters of Double Spiral Freezer

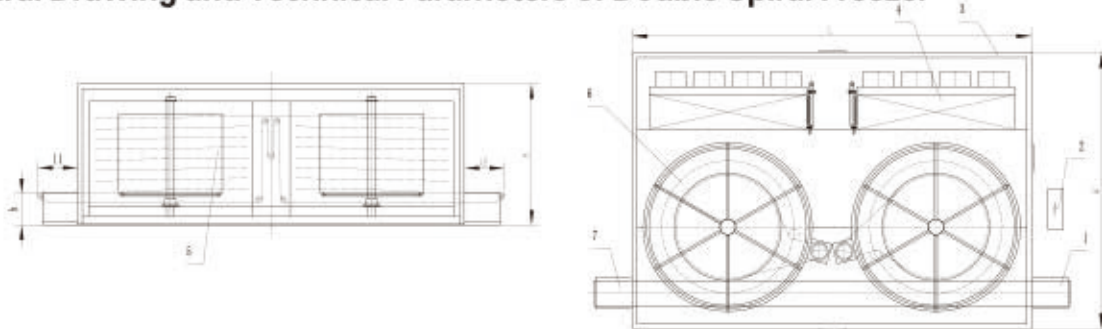

Main Tech. Para. of Double Spiral Quick-Freezing Equipment
For example as headless shrimp; refrigeration condition: T₀=-40°C T_k=35°C

Model Para. Item	Output (kg/h)	Feeding temp. (°C)	Outfeeding temp. (°C)	Cycle cold air temp. when no loading (°C)	Installed power (kw)	Dimension of quick freezing room (L×W×H) (m)	Overall length for mesh belt (m)	Overall width for mesh belt (mm)	Required refrigeration capacity (kw)	Number of layers	Height between layers (mm)
SLX-800	800	15	-18	-30±2	28	10.4×7.2×2.85	235	650	145	2×8	145
SLX-1000	1000	15	-18	-30±2	28	10.4×7.2×3	260	650	180	2×9	145
SLX-1500	1500	15	-18	-30±2	37	11.05×7.5×3.35	370	710	260	2×12	180
SLX-2000	2000	15	-18	-30±2	46	11.05×7.5×4.35	485	710	350	2×16	180

Advantages of Double Spiral Freezer

◆High Freezing Capacity

Double turning drums can effectively play advantages of spiral freezer, as such double spiral freezer is highly suitable for large production.

◆Modernization Design

Inlet and outlet of double spiral freezer are all installed on the bottom of the equipment, so that it can equip with other assembled equipments achieving modernization production.

◆More Applicable and Flexible in Various Freezing Products

Double spiral freezer can run separately, which can decrease precooling process and related equipments, finishing precooling and quick-freezing at a time. This equipment is also suitable for bulk foods that need long freezing time.



Structure of Batch-type Vacuum Frying Machine

Vacuum frying machine is made up of vacuum frying tank, frying and de-oil basket, driving motor, vacuum system and oil circulation system. This equipment adopts the Dutch technique completely, which can not only ensure the quality of equipment, but also greatly consider the requirements on energy conservation and environmental protection. Through PLC and touch screen (HMI), a complete automatic control mode is implemented.

Products are deeply fried and dehydrated in vacuum environment. This can reduce the damage of the nutrient content effectively. With good expansion effect of fried foods, color and perfume can be preserved, crispy and delicious. Frying temperature is controlled from 80 ~ 120 °C, which greatly prevent harmful substances. Deep-frying and centrifugal oil removal are completed successively in vacuum condition. The minimum oil rate of finished product can be controlled within 20%.



Following foods can be processed:

Fruits: apple, banana, kiwi, pineapple, persimmon, strawberry, grape, peach, pear, etc.

Vegetables: tomato, sweet potato, potato, green bean, mushroom, garlic, green pepper, squash, onion, okra, etc.

Dried fruits: peanut, jujube, etc.

Aquatic products and domestic animal, poultry meat.

Technical Parameters

Product model	Diameter of frying tank (mm)	Quantities of basket (Pcs)	Working vacuum pressure (Pa)	Heating method	Installed power (Kw)	Dimension (mm)
BVF-10	500	2	<4000	Electricity	15Kw, 380v	2800x2500x2600
BVF-20	600	3	<4000	Electricity or steam	18Kw, 380v	3000x2800x2800
BVF-30	850	3	<4000	Electricity or steam	25Kw, 380v	3300x3280x2800
BVF-60	2x850	2x3	<4000	Electricity or steam	40Kw, 380v	6000x3200x2800



Structure of Continuous Vacuum Frying Machine

Continuous vacuum frying machine is composed of vacuum chamber, deep-frying pan, rotating valve of in-feed, centrifugal de-oiling device, vacuum system and oil circulation system. This equipment adopts the Dutch technique completely, which can not only ensure the quality of equipment, but also greatly consider the requirements on energy conservation and environmental protection. Through PLC and touch screen (HMI), a complete automatic control mode is implemented.

Products are deeply fried and dehydrated in vacuum environment. This can reduce the damage of the nutrient content effectively. With good expansion effect of fried foods, color and perfume can be preserved, crispy and delicious. Frying temperature is controlled from 80 ~ 120 ℃, which greatly prevent harmful substances. Deep-frying and centrifugal oil removal are completed successively in vacuum condition. The minimum oil rate of finished product can be controlled within 20%.

This equipment is mainly used for products such as potato, sweet potato and green beans, etc.



Advantages of the Equipment:

Using the same process parameters in the frying process ensures that the product has the same quality. For example, in aspects of product color, taste, nutrient content, etc., this equipment can produce better products than batch-type deep-frying machine. It is especially suitable for large factory for continuous processing output.

Technical Parameters

Product model	Chamber diameter (mm)	Centrifugal speed (RPM)	Working vacuum pressure (Pa)	Heating method	Installed power (Kw)	Dimension (mm)
CVF-100	800	50 ~ 400	<6000	Steam or thermal oil	40Kw, 380v	10000x4080x3600
BVF-200	900	50 ~ 400	<6000	Steam or thermal oil	50Kw, 380v	12000x4180x3800
BVF-300	1000	50 ~ 400	<6000	Steam or thermal oil	65Kw, 380v	14000x4280x4000



TS/KS Series Food Quick Freezing Equipment

Stainless steel mesh belt be used as transmission belt,feeding materials which are to be frozen being placed on pallet, realizing quick and complete freezing through side or top blowing cold air.

It is most suitable for processing of spring roll,steamed dumpling with dough gather at the top, meat ball and fish etc. The selective range for freezing time is 15 ~ 100 minutes.

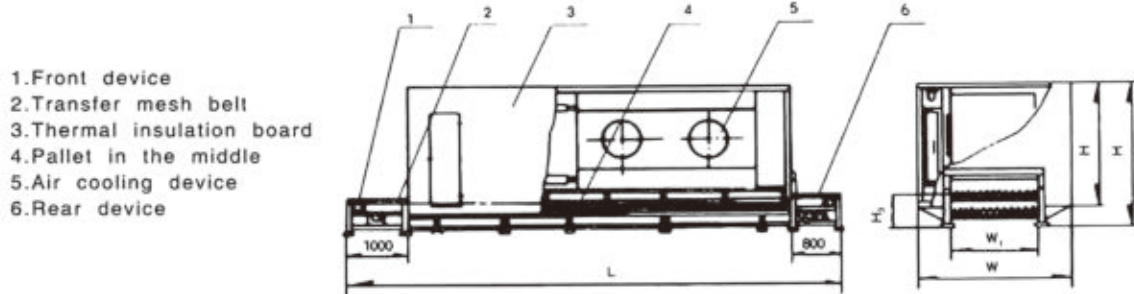

- 1.Front device
- 2.Transfer mesh belt
- 3.Thermal insulation board
- 4.Pallet in the middle
- 5.Air cooling device
- 6.Rear device

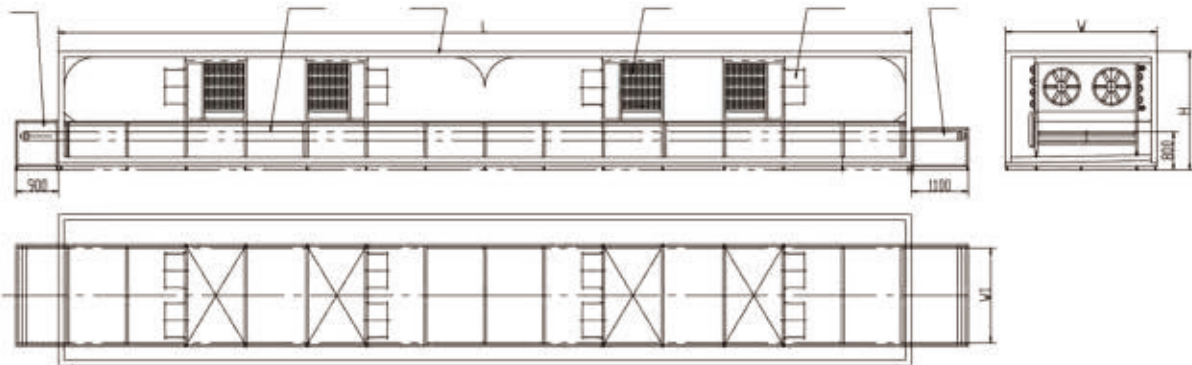

Main Tech. Para. for TS Series Flavored food Quick-Freezing Equipment

Parameter Item	Model	TS-150	TS-300	TS-500	TS-600	TS-1000	KS-500	KS-1000	KS-1500
Output kg/h		150(dumplings, spring roll)	300(dumplings spring roll)	500(dumplings spring roll)	600(dumplings spring roll)	1000(dumplings spring roll)	500(dumplings)	1000(dumplings)	1500(dumplings)
Feeding temp. °C		25	25	25	25	25	15	15	15
Outfeeding temp. °C		-18	-18	-18	-18	-18	-18	-18	-18
Cycle cold air tem. when no loading °C		-35±2	-35±2	-35±2	-35±2	-35±2	-35±2	-35±2	-35±2
Installed power(kw)		6	9	10.9	19.8	28.6	11	26	30
Dimension of quick freezing room(L x W x H)m		8.1×2.5×2.2	12.6×2.5×2.2	16.2×2.5×2.2	16.2×2.8×2	21.6×3.2×2	15×3×3.05	22.5×3.6×3.05	22.5×4.8×3.05
Overall length for quick freezing device(m)		10.1	14.6	18.2	18.2	23.6	17	23.5	23.5
Refrigerate capacity (to=-40°C) kw		58	85	122	132	185	120	185	270
Features		Carbon steel hot deep galvanized evaporator, stain less steel mesh belt, additional thermal insulation foundation is unnecessary.			Aluminium evaporator, stainless steel mesh belt/transfer, additional thermal insulation foundation is unnecessary.				



SS Series Food Quick Freezing Equipment

SS series fluidized bed quick freezer use stainless steel mesh belt as a conveyor, and integrated with a mechanical impulse device, the cold air blow upward through the product and makes it in fluidized and individual quick freezing.

Suitable for vegetable, fruits's quick freeze. The freezing time range can adjustable from 4-60min.

SSDX-500 1000

- | | |
|------------------------------------|-------------------------------------|
| 1, lifter | 5, conveyor |
| 2, vibration product feeder | 6, safe guard |
| 3, Forepart of transmission device | 7, rear part of transmission device |
| 4, air chamber | 8, Fan |

- | |
|------------------------------|
| 9, mechanical impulse device |
| 10, Freezing tunnel |
| 11, Evaporator |
| 12, Insulated enclosure |

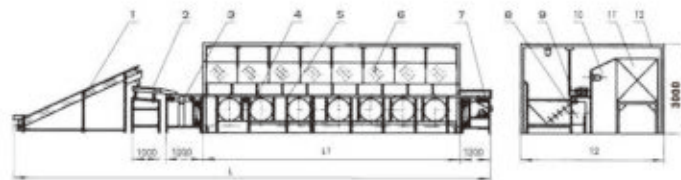

SSDX-1500 2000 3000

- | | |
|------------------------------------|-------------------------------------|
| 1, lifter | 5, conveyor |
| 2, vibration product feeder | 6, safe guard |
| 3, Forepart of transmission device | 7, rear part of transmission device |
| 4, air chamber | 8, Fan |

- | |
|------------------------------|
| 9, mechanical impulse device |
| 10, Freezing tunnel |
| 11, Evaporator |
| 12, Insulated enclosure |

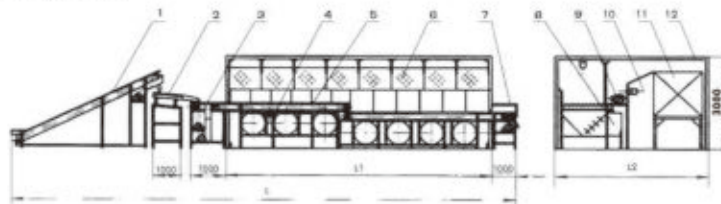

Main Tech. Para. for SS Series Fluidized Bed Quick-Freezing Equipment

Parameter \ Model	SS-500	SS-1000	SS-1500	SS-2000	SS-3000
Output kg/h	500 (pea)	1000 (pea)	1500 (pea)	2000 (pea)	3000 (pea)
Feeding temp. °C	15	15	15	15	15
Outfeeding temp. °C	-18	-18	-18	-18	-18
Cycle cold air tem. when no loading °C	-35 ± 2	-35 ± 2	-35 ± 2	-35 ± 2	-35 ± 2
Installed power(kw)	17.1	29	35	50.2	67
Dimension of quick freezing room (L × W × H)m	5.4 × 4.4 × 3	8.1 × 4.7 × 3	10.8 × 4.7 × 3	14.4 × 4.7 × 3	1.8 × 4.7 × 3
Overall length for quick freezing device(m)	7.5	10.1	12.9	16.5	20
Refrigerate capacity (L ₀ =-40°C) kw	100	186	256	326	453
Features	Aluminium evaporator conveyor is in one sections		Aluminium evaporator conveyor is apart in two sections	Aluminium evaporator conveyor is apart in two sections	



JS Series Food Quick Freezing Equipment

JS series plate belt type quick-freezing equipment uses stainless steel plate as transfer belt, marine products such as headless shrimp, scallop etc which are to be frozen being placed on belt, having feeding materials quickly frozen in individual type through side blowing cold air. This series of equipments mainly process marine products. The selective range for freezing time is 10-100 minutes.

1. Front device
2. Transfer plate belt
3. Cleaning device
4. Thermal insulation board
5. Air cooling device
6. Evaporator
7. Rear device

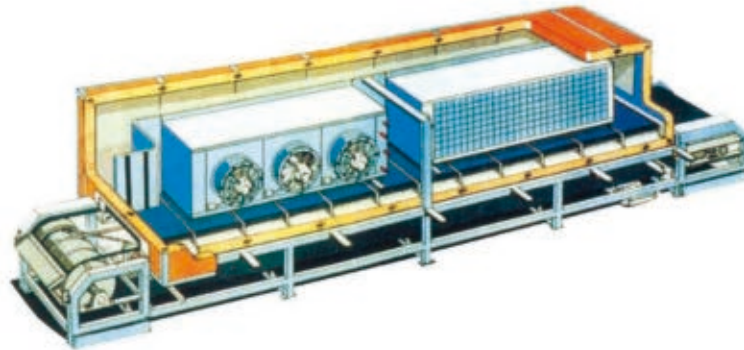
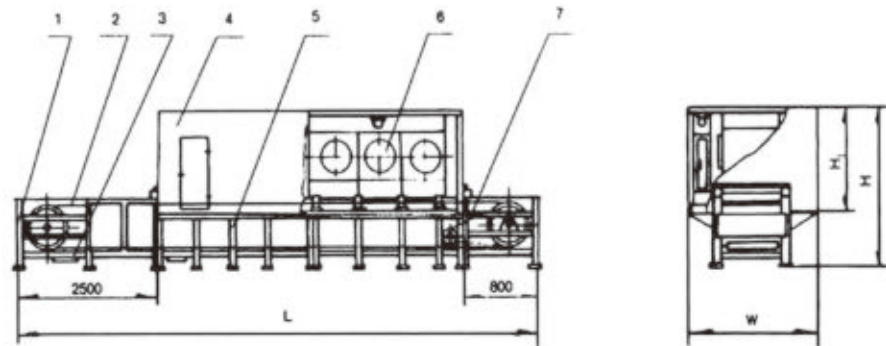

Main Tech. Para. for JS Series food Quick-Freezing Equipment

Parameter / Model	JSG-300	JSG-200	JSG-500
Output kg/h	300 headless shrimp	200-250 headless shrimp	500-550 headless shrimp
Feeding temp. °C	10	10	10
Outfeeding temp. °C	-18	-18	-18
circulating cold air tem, when no loading, °C	-35 ± 2	-35 ± 2	-35 ± 2
Installed power(kw)	10.5	10.1	16.2
Dimension of quick freezing room (L x W x H)m	12.6 x 2.5 x 1.9	10.8 x 2.5 x 1.9	18 x 2.5 x 1.9
Overall length for quick freezing device(m)	15.9	14.1	21.3
Refrigerate capacity (t ₀ = -40°C) kw	105	82	135
Features	Aluminium evaporator, additional thermal insulation foundation is unnecessary.		



Design Principle

DSA equipment is supported by side plates installed on both sides of conveyor belt. The upper layer provides support to the lower layer without needs for orbit. Entering from the bottom, the conveyor belt rotates a circle to rise a thread pitch; at the same time, the second mesh belt enters to support the former layer. Accumulations layer by layer form an overall barrel shape, outputting from the highest layer finally. The cold air enter from the upper layer and are restricted in the circular passage enclosed by side plates that are installed on both sides of conveyor, freezing materials by belowing layers.

Main Characteristics

- Compact design and less occupied area
- Unique ventilation, superior quality and high production efficiency
- Efficient usage on energy and low basic energy-consumption
- Reasonable design and more reliable operation
- Simple operation, easy maintenance and cleaning

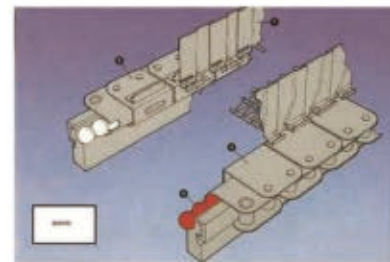
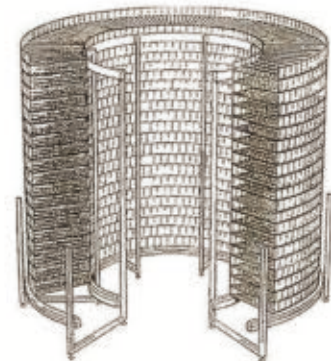

Spiral series of quick-freezing device is suitable for the following goods:

1. Prepared food: Dumplings, rice dumpling, steamed stuffed bun, spring roll, meat ball, fried product, ice cream and small package food.
2. Aquatic products: Fish, shrimp, crab and scallop, etc.
3. Meat: Kebab and dressed meat, etc.
4. Baked food: Bread, etc.; Fermentation of various pastries.

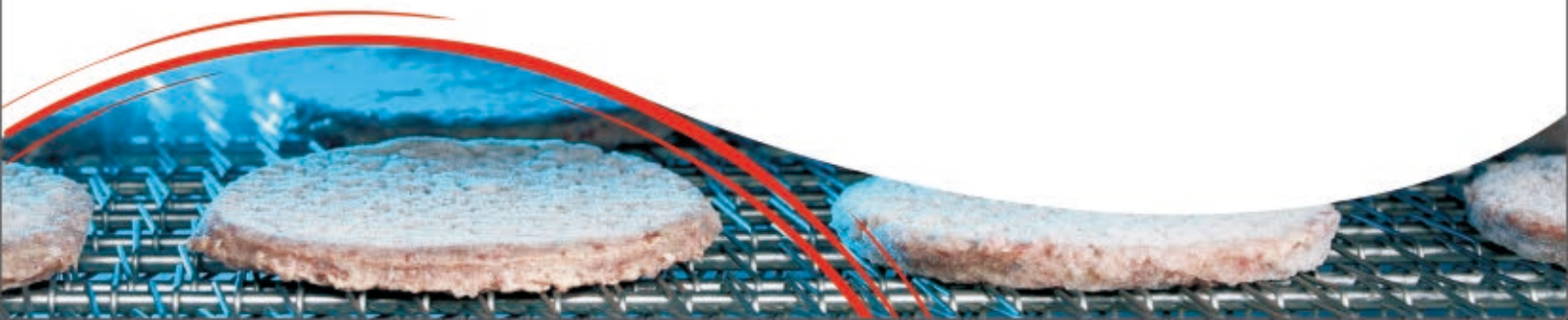

DSA Self-stacking Spiral Freezer

Structural Drawing and Technical Parameters

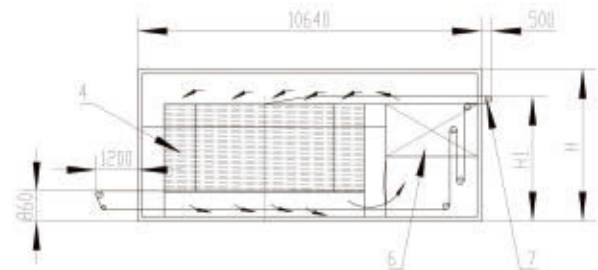
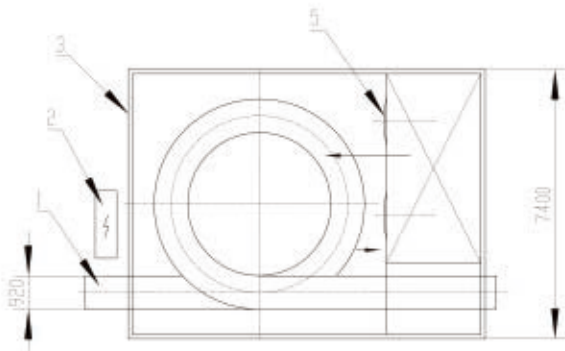

1. Feeding device 2. Power distribution cabinet 3. Insulation board 4. Turning drum
5. Centrifugal fan 6. Evaporator 7. Outfeeding device

For example as dumplings; refrigeration condition: $T_0 = -40^{\circ}\text{C}$ $T_k = 35^{\circ}\text{C}$

Model	Item Para.	Output (kg/h)	Feeding temp. ($^{\circ}\text{C}$)	Outfeeding temp. ($^{\circ}\text{C}$)	Cycle cold air temp. when no loading ($^{\circ}\text{C}$)	Installed power (kw)	Dimension of quick freezing room (L×W×H) (m)	Overall length for mesh belt (m)	Required refrigeration capacity (kw)	Number of layers	Height of outfeeding (mm)
DSA-3000		3000	15	-18	35 ± 2	40	10640×7400×5250	435	337	20	3650
DSA-6000		6000	15	-18	35 ± 2	66	10640×7400×5250	750	650	40	4525

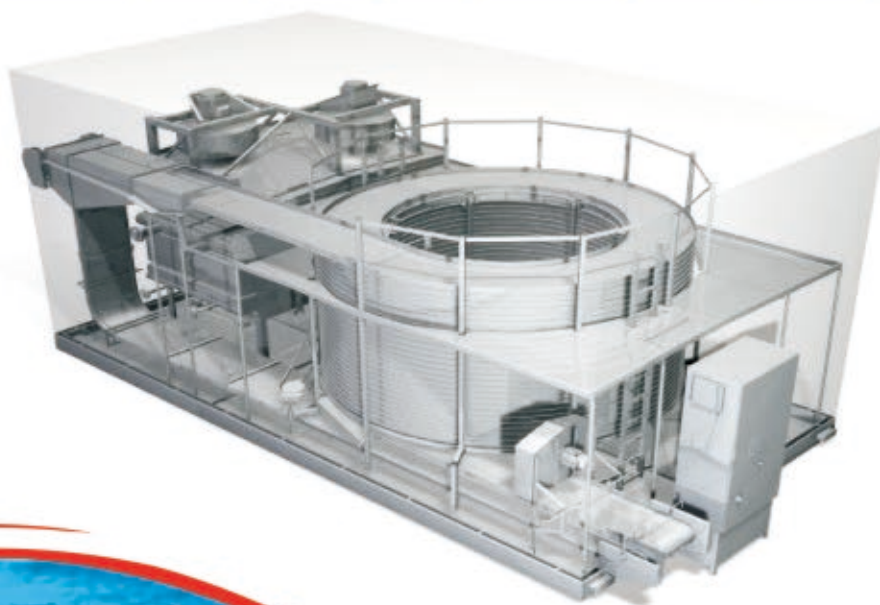



荣誉与认证

Certificates

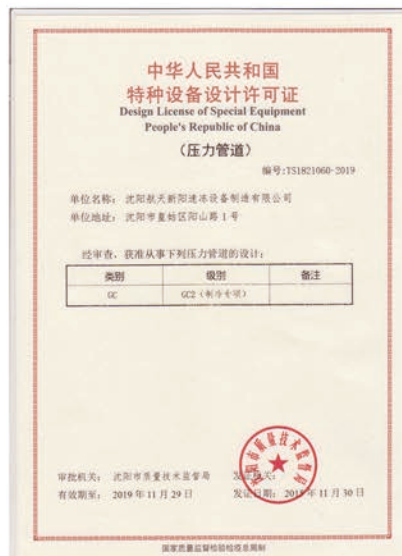

XIN YANG

新的

地址：中国沈阳市皇姑区三台子阳山路一号

Address: Yang shen Road No.1 Santaizi Huanggu District Shenyang city Liaoning Pro China

电话 (Tel) : 0086-024-86525079 88085770

传真 (Fax) : 0086-024-86520145 86520296

网址 (Http) : <http://www.freezedry.cn>

E-mail: sysudong@126.com

